

HERRINGBONE HYBRID FLOORING

INSTALLATION GUIDE

Easy to Install



Easy to clean



Durable



25 Year Warranty

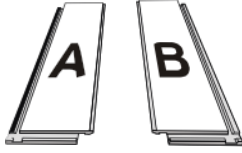

Box contains: 24 pieces
Pack Size: 1.875m²

Board Dimensions: 625mm x 125mm

Two different types of boards are used to lay out the herringbone pattern. These are referred to as PLANK A and PLANK B.
N.B. - Please separate A and B planks into 2 separate stacks prior to commencing installation.

Care Instructions

Hybrid herringbone click flooring is extremely easy to clean.

Routine Cleaning

- Vacuum use a dust mop or wipe with a damp cloth. For spills, just wipe up with a cloth.
- Do not use soap-based detergents, as these may leave a dull film on your floor.
- Do not wax or polish your floor.
- Do not use abrasive cleaners, steel wool, or scouring powder, which can scratch your floor.
- SPC flooring, even it is completely waterproof, but like other types of smooth floors, it can become slippery when wet. Wipe up wet areas caused by spillages, foreign substances and wet feet.

Protection

Place a natural or color fast mat at outside entrances to collect tracked-in dirt and absorb excess moisture

For added protection to the flooring surface, use floor protectors on chairs and other furniture. The heavier the item, the wider the floor protector should be.

Where to Install

All floor areas including basements. Over smooth, well bonded vinyl floors, over concrete, ceramic tile, terrazzo, marble and board type underlayment.

Subfloor preparations

Subfloor must be clean, dry and level. Remove existing skirting or trim. Door trims and doorjamb must be undercut to allow the floor to move freely.

HERRINGBONE HYBRID FLOORING INSTALLATION GUIDE

Installation Guide

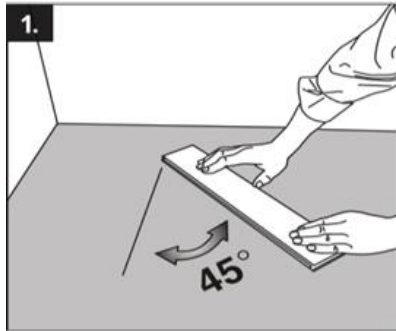

1. Getting started

Choose a wall to start at and begin installing at the left corner. Start with an A-panel and place it with its long side facing the left wall at an angle of 45°. Make sure that the distance between the left wall and the panel is less than the length of one panel.

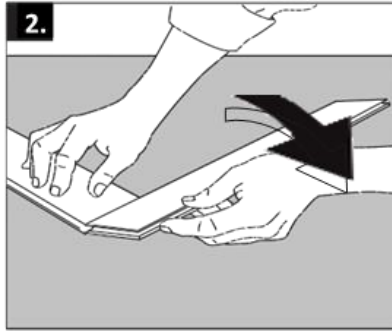

2. Connect next panel

Continue with a B-panel. Press the long side of the B-panel at an angle against the short side of the previous installed A-panel. Insert and fold down the B-panel flat to the floor to lock the panels tightly together. Check that the grooves on the two panels form a continuous line.

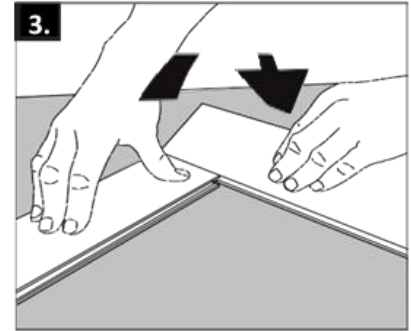

3. Connect additional panels

Next panel is an A-panel. Again, press the long side of the new A-panel at an angle against the short side of the previous B-panel insert and fold down. Continue like this with as many panels as may fit along the starting wall.

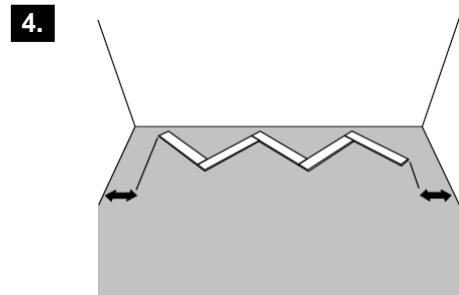

4. Center the first row

Check that the first row of panels is centered along the starting wall. Make sure that the distance to the walls on both sides are less than the length of one panel. If not, add a panel at the right side.

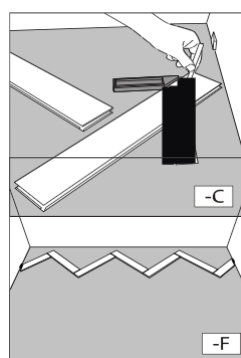
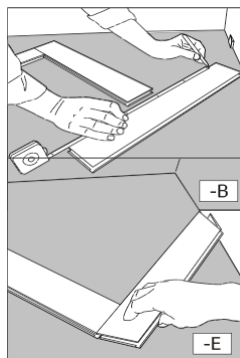
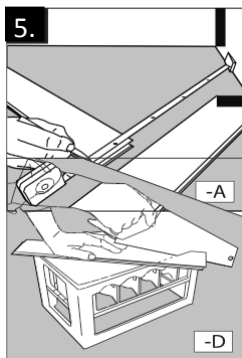

5. Cut the end panels to size

Measure and cut the end panels to size using a fine-toothed saw. Finish the first row with the cut end panels. Make sure that you leave a gap of 10/12mm to each wall.



HERRINGBONE HYBRID FLOORING INSTALLATION GUIDE

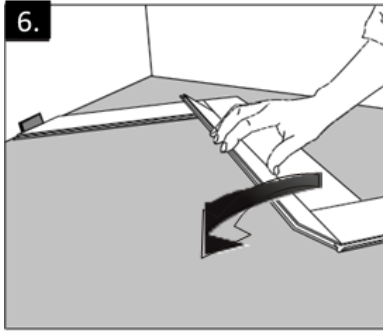

6. Start the second row

Start the next row with an A-panel. Place the new panel against the previous row insert and fold down. Next tap the short side home.

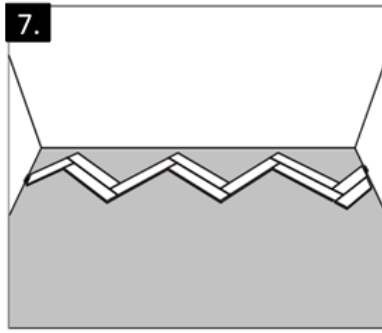

7. Install the A-panels

Continue from the left to the right and install all the A-panels in the second row. Finish with a piece of panel cut to size (step 5).

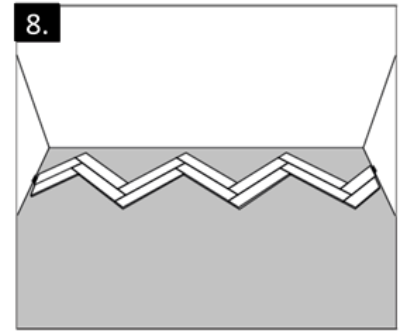

8. Continue with the B-panels

Now work in the opposite direction, from the right to the left and install all the B-panels in the second row. Finish with a piece of panel cut to size (step 5).

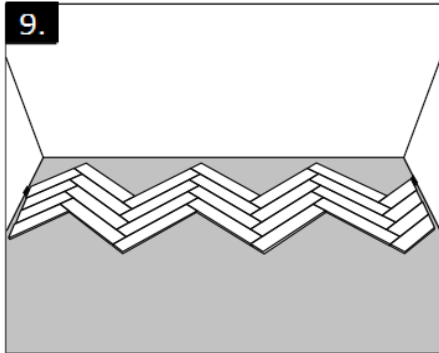

9. N.B - Complete four rows
Important Note: Install additional rows to complete four full rows.

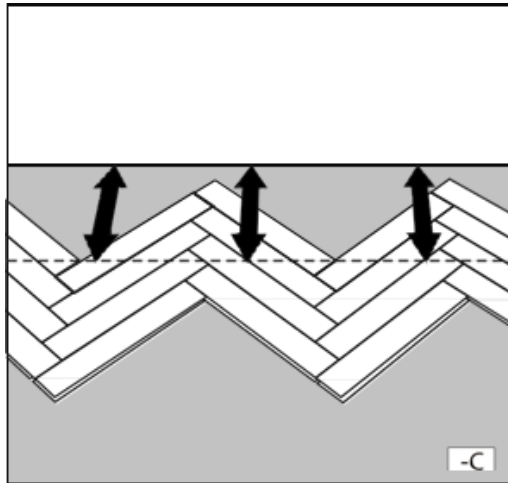
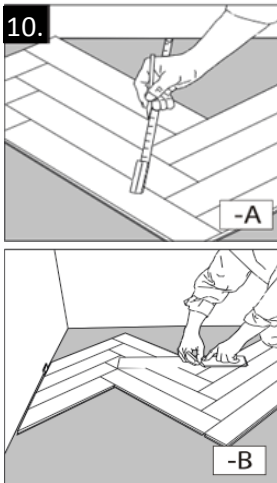

10. Adjust the starting rows

The first four rows have to be cut parallel to the wall. Measure and mark where to cut the floor panels at a fixed / parallel distance to the wall.

HERRINGBONE HYBRID FLOORING INSTALLATION GUIDE

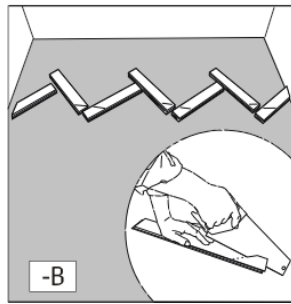
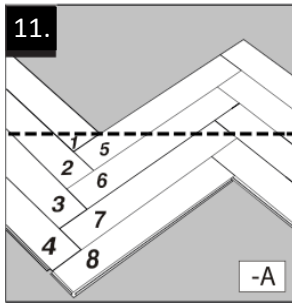

11. Dismantle and cut

Number the panels from 1 to This will allow you to keep the panels in order. Dismantle the panels and cut them to size along the previous marked line.

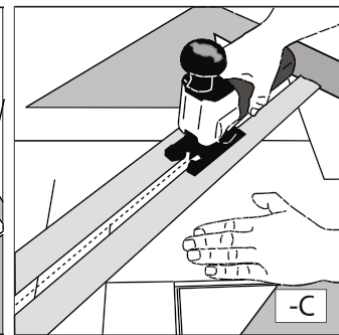
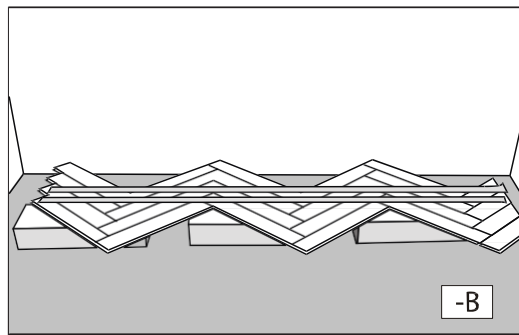
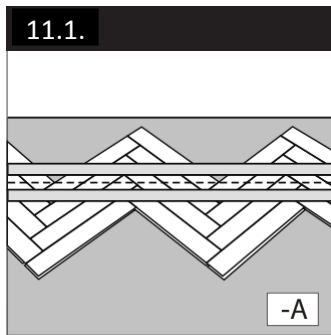

11.1 Alternative way to cut the first rows

Leave the left end-panels uninstalled. Tape along the marked line and place the flooring on top of a few flooring packages. Cut along the marked line. Then put the adjusted rows into place. Complete the first rows by installing the remaining end-panels. Start with the end-panel in the last row and finish at the first row.

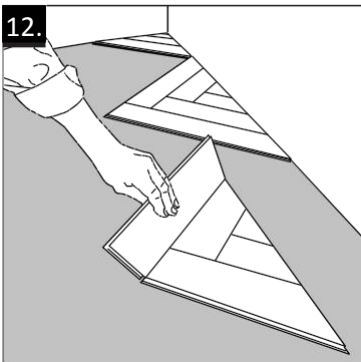

12. Install the starting triangles

Connect the cut starting panels to form triangular shapes, one by one. Start installing the triangles from the left corner. It is recommended to use glue to fix the smallest parts of the triangles into place by applying a small quantity of glue inside the groove.

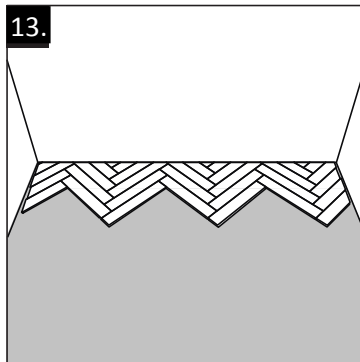

13. Install a few more rows

Connect the triangles by installing a few additional rows of panels. Start each row from the left to the right with the A-panels, finish with the cut piece of panel (step 5) and then install all the B-panels in the row. Finish with the left end panel, cut to size.

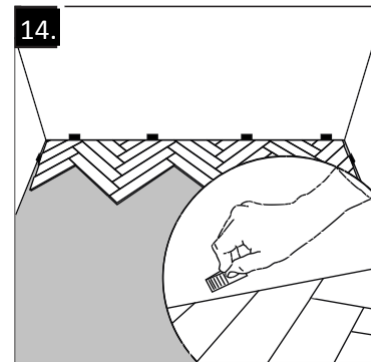

14. Put in spacers

Put in spacers between the flooring and the wall to ensure an expansion gap of 10/12mm.

HERRINGBONE HYBRID FLOORING INSTALLATION GUIDE

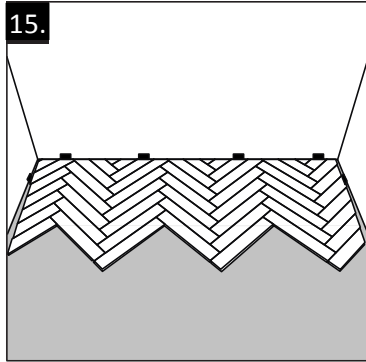

15. Subsequent rows

Start each subsequent row by installing the A-panels from the left to the right and complete the row by laying the B-panels from the right to the left.

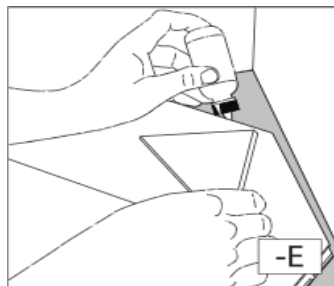
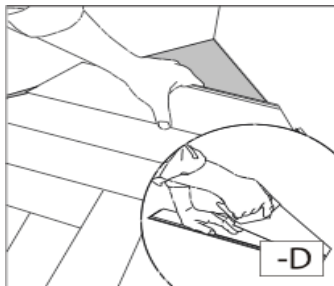
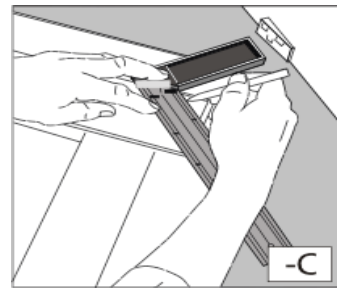
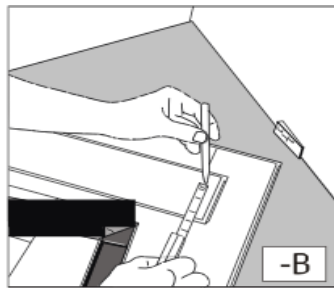
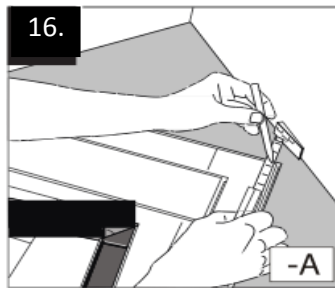

16. Last row

Measure and cut the panels in the last row to size.

It is recommended to use glue to install the smallest pieces of panels. Apply a small quantity of glue inside the groove.

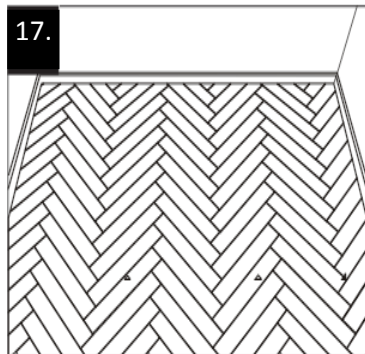

17. Spacers and skirting

Remove the spacers and cover the expansion gap with skirting boards or beadings.